

TE
connectivity

AUTHORIZED DISTRIBUTOR

2016

HAZİRAN FİYAT LİSTESİ





RT RÖLE TEKNİK

www.roleteknik.com.tr



XT SERİSİ RÖLELER

- 1 Kontakt 16 A, 2 Kontakt 8 A
- DC ve AC Bobin 400 mW
- Koruma Sınıfı II (VDE 0700)
- 4kV/8 mm Bobin Kontakt İzalasyonu
- Manuel Test Butonu
- Test Butonunun Kilitlenme Özelliği
- LED ve Koruma Diyodu İçinde
- RT Soketlere Uygun



 REG.-Nr. B758,  E214025



TE ETİKETLEME ÇÖZÜMLERİ

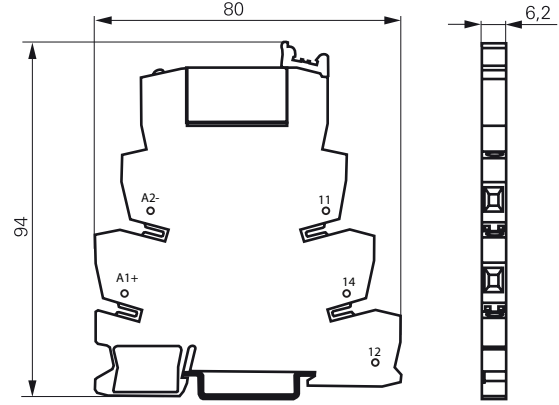



SİP NO	TİPİ	AÇIKLAMA	Paket M.	FİYAT
PLC RÖLE SETLERİ (6 mm)				
001.004.001.001.0001	ST3P3LB2	012 VDC 1 C/O 6A SLİM RÖLE + VİDALI SOKET		
001.004.001.001.0002	ST3P3LC4	024 VDC 1 C/O 6A SLİM RÖLE + VİDALI SOKET	10	9,20 €
001.004.001.001.0004	ST3P3SM5	115 VAC 1 C/O 6A SLİM RÖLE + VİDALI SOKET		
001.004.001.001.0005	ST3P3TP0	230 VAC 1 C/O 6A SLİM RÖLE + VİDALI SOKET	10	10,00 €
001.004.001.001.0011	V23092-12 SET	012 VDC 1 C/O 6A SCHRACK RÖLE + EKO SOKET	10	7,00 €
001.004.001.001.0012	V23092-24 SET	024 VDC 1 C/O 6A SCHRACK RÖLE + EKO SOKET	10	7,00 €
001.004.001.001.0010	PLF-X24/LR24	024 VDC 1 C/O 6A SLİM RÖLE + VİDALI SOKET (EKONOMİK)	10	5,60 €

SİP NO	TİPİ	AÇIKLAMA	Paket M.	FİYAT
PLC OPTOKUPLÖRLER (6 mm)				
001.001.002.008.0017	SSR 01D-224	24/24 DC 2 A SOLID STATE RÖLE	10	12,00 €
001.001.002.008.0018	SSR 20-524D	24/24 DC 5 A SOLID STATE RÖLE	10	13,00 €
001.004.001.007.0005	SSR 24/24 ECO SET	24/24 DC 2 A SOLID STATE RÖLE + SLİM SOKET	10	17,00 €

SİP NO	TİPİ	AÇIKLAMA	Paket M.	FİYAT
PLC RÖLELER (6 mm)				
001.001.001.001.0018	LR-SS-124D	024 VDC 1 C/O 6A SLİM RÖLE 170 mW (EKONOMİK)	50	2,50 €
001.001.001.001.0002	V23092-A1005-A301	005 VDC 1 C/O 6A SLİM RÖLE 170 mW	20	3,80 €
001.001.001.001.0004	V23092-A1012-A301	012 VDC 1 C/O 6A SLİM RÖLE 170 mW	20	3,80 €
001.001.001.001.0007	V23092-A1024-A301	024 VDC 1 C/O 6A SLİM RÖLE 170 mW	20	3,80 €
001.001.001.001.0016	PCN105-D3MHZ	005 VDC 1 N/O 3A PLC RÖLESİ 120 mW	160	2,57 €
001.001.001.001.0017	PCN112-D3MHZ	012 VDC 1 N/O 3A PLC RÖLESİ 120 mW	160	2,57 €
001.001.001.001.0015	PCN124-D3MHZ	024 VDC 1 N/O 3A PLC RÖLESİ 120 mW	25	2,57 €

SİP NO	TİPİ	AÇIKLAMA	Paket M.	FİYAT
PLC RÖLE AKSESUARLARI				
001.002.001.001.0001	ST36040	SOKET AYIRMA PLAKASI	10	2,50 €
001.002.001.001.0002	ST37001	50 CM KÖPRÜ KIRMIZI (80 SOKET KÖPRÜLER)	1	17,20 €
001.002.001.001.0003	ST37002	50 CM KÖPRÜ MAVİ (80 SOKET KÖPRÜLER)	1	17,20 €
001.002.001.001.0004	ST37003	50 CM KÖPRÜ GRİ (80 SOKET KÖPRÜLER)	1	17,20 €
004.003.000.000.0077	UCTM	SLİM SOKET ETİKETİ (1PLK = 80 ADET)	1 PLK	5,80 €
001.002.001.001.0010	KB 20	EKONOMİK SERİ SLİM SOKET BARASI 20'Lİ	10	2,00 €
001.003.001.001.0005	PLF-X24	SLİM RÖLE SOKETİ (EKONOMİK) 88.6 x 76 x 6.02	20	5,00 €

SİP NO	TİPİ	AÇIKLAMA	Amb.	FİYAT
RT SERİSİ RÖLELER (400 mW)				
001.001.001.003.0003	RT 114012	012 VDC 1 C/O 12A PCB RÖLE 5 PIN 3.5 mm	20	2,25 €
001.001.001.003.0004	RT 114024	024 VDC 1 C/O 12A PCB RÖLE 5 PIN 3.5 mm	20	2,25 €
001.001.001.003.0005	RT 114730	230 VAC 1 C/O 12A PCB RÖLE 5 PIN 3.5 mm	20	4,50 €
001.001.001.003.0006	RT 214012	012 VDC 1 C/O 12A PCB RÖLE 5 PIN 5.0 mm	20	2,22 €
001.001.001.003.0007	RT 214024	024 VDC 1 C/O 12A PCB RÖLE 5 PIN 5.0 mm	20	2,22 €
001.001.001.003.0008	RT 214730	230 VAC 1 C/O 12A PCB RÖLE 5 PIN 5.0 mm	20	4,25 €
001.001.001.003.0009	RT 314005	005 VDC 1 C/O 16A PCB RÖLE 8 PIN	20	2,75 €
001.001.001.003.0011	RT 314012	012 VDC 1 C/O 16A PCB RÖLE 8 PIN	20	2,22 €
001.001.001.003.0012	RT 314024	024 VDC 1 C/O 16A PCB RÖLE 8 PIN	20	2,22 €
001.001.001.003.0014	RT 314524	024 VAC 1 C/O 16A PCB RÖLE 8 PIN	20	2,90 €
001.001.001.003.0016	RT 314730	230 VAC 1 C/O 16A PCB RÖLE 8 PIN	20	4,35 €
001.001.001.003.0031	RT 424012	012 VDC 2 C/O 08A PCB RÖLE 8 PIN	20	2,25 €
001.001.001.003.0032	RT 424024	024 VDC 2 C/O 08A PCB RÖLE 8 PIN	20	2,25 €
001.001.001.003.0062	RT 424005C	005 VDC 2 C/O 08A PCB RÖLE 8 PIN ŞEFFAF	20	2,25 €
001.001.001.003.0056	RT 424012C	012 VDC 2 C/O 08A PCB RÖLE 8 PIN ŞEFFAF	20	2,25 €
001.001.001.003.0057	RT 424024C	024 VDC 2 C/O 08A PCB RÖLE 8 PIN ŞEFFAF	20	2,25 €
001.001.001.003.0033	RT 424048	048 VDC 2 C/O 08A PCB RÖLE 8 PIN	20	2,64 €
001.001.001.003.0034	RT 424060	060 VDC 2 C/O 08A PCB RÖLE 8 PIN		☎
001.001.001.003.0035	RT 424110	110 VDC 2 C/O 08A PCB RÖLE 8 PIN	20	4,80 €
001.001.001.003.0036	RT 424524	024 VAC 2 C/O 08A PCB RÖLE 8 PIN	20	3,05 €
001.001.001.003.0037	RT 424548	048 VAC 2 C/O 08A PCB RÖLE 8 PIN	20	3,40 €
001.001.001.003.0038	RT 424730	230 VAC 2 C/O 08A PCB RÖLE 8 PIN	20	4,34 €
001.001.001.003.0058	RT 424615	115 VAC 2 C/O 08A PCB RÖLE 8 PIN	20	4,45 €
001.001.001.003.0046	RT 33L012	012 VDC 1 N/O 16A INRUSH RÖLE (20mS-80A)	20	2,85 €
001.001.001.003.0026	RT 33L024	024 VDC 1 N/O 16A INRUSH RÖLE (20mS-80A)	20	2,95 €
001.001.005.001.0005	RTS3LA12	012 VDC 1 N/O 16A INRUSH BISTABLE RÖLE (20mS-120A)	20	3,95 €
001.001.005.001.0003	RTS3TA12	012 VDC 1 N/O 16A INRUSH BISTABLE RÖLE (20mS-165A)	20	4,50 €
RX SERİSİ PCB RÖLELER (500 mW)				
001.001.001.002.0001	RX 114012	012 VDC 1 C/O 12A PCB RÖLE 5 PIN 3.5 mm	20	1,95 €
001.001.001.002.0005	RX 114730	230 VAC 1 C/O 12A PCB RÖLE 5 PIN 3.5 mm	20	4,25 €
001.001.001.002.0021	RX 424024C	024 VDC 2 C/O 08A PCB RÖLE 8 PIN ŞEFFAF	20	2,20 €
001.001.001.002.0022	RX 424048	048 VDC 2 C/O 08A PCB RÖLE 8 PIN BEYAZ	20	2,50 €
RZ SERİSİ PCB RÖLELER (400 mW)				
001.001.001.006.0011	RZ01-1C4-D012-R	012 VDC 1 C/O 12A PCB RÖLE 5 PIN 3.5 mm	20	1,85 €
001.001.001.006.0010	RZ01-1C4-D024-R	024 VDC 1 C/O 12A PCB RÖLE 5 PIN 3.5 mm	20	1,85 €
001.001.001.006.0014	RZ03-1C4-D005-R	005 VDC 1 C/O 16A PCB RÖLE 8 PIN	20	1,85 €
001.001.001.006.0013	RZ03-1C4-D012-R	012 VDC 1 C/O 16A PCB RÖLE 8 PIN	20	1,85 €
001.001.001.006.0012	RZ03-1C4-D024-R	024 VDC 1 C/O 16A PCB RÖLE 8 PIN	20	1,85 €
V23057 VE RP SERİSİ PCB RÖLELER (450-500 mW)				
001.001.001.005.0004	V23057-B0002-A101	012 VDC 1 C/O 08A PCB RÖLE (DİK TİP)		☎
001.001.001.005.0005	V23057-B0006-A101	024 VDC 1 C/O 08A PCB RÖLE (DİK TİP)		☎
001.001.001.005.0006	V23057-B0028-A401	110 VDC 1 C/O 08A PCB RÖLE (DİK TİP)		☎
001.001.001.004.0020	RP 410012	012 VDC 1 C/O 12A PCB RÖLE 5 PIN	20	2,80 €
001.001.001.004.0031	RP 420024	024 VDC 2 C/O 08A PCB RÖLE 8 PIN	20	2,80 €
XT SERİSİ ENDÜSTRİYEL RÖLELER (400 mW)				
001.001.002.001.0001	XT 374LC4	024 VDC 1 C/O 16A END. RÖLE (T.BUTON+LED+KD)	10	4,20 €
001.001.002.001.0002	XT 374R24	024 VAC 1 C/O 16A END. RÖLE (T.BUTON+LED)		☎
001.001.002.001.0003	XT 374T30	230 VAC 1 C/O 16A END. RÖLE (T.BUTON+LED)	10	5,70 €
001.001.002.001.0004	XT 484LC4	024 VDC 2 C/O 16A END. RÖLE (T.BUTON+LED+KD)	10	4,70 €
001.001.002.001.0005	XT 484R24	024 VAC 2 C/O 16A END. RÖLE (T.BUTON+LED)	10	6,00 €
001.001.002.001.0006	XT 484T30	230 VAC 2 C/O 16A END. RÖLE (T.BUTON+LED)	10	6,30 €
RT SERİSİ RÖLE SETLERİ				
001.004.001.008.0009	RT3A4L24	024 VDC 1 C/O RÖLE + SOKET + LED MODÜL + KLİPS + ETİKET		☎
001.004.001.008.0010	RT3A4R24	024 VAC 1 C/O RÖLE + SOKET + LED MODÜL + KLİPS + ETİKET		☎
001.004.001.008.0011	RT3A4T30	230 VAC 1 C/O RÖLE + SOKET + LED MODÜL + KLİPS + ETİKET		☎
001.001.001.003.0063	RT4A4L24	024 VDC 2 C/O RÖLE + SOKET + LED MODÜL + KLİPS + ETİKET		☎
001.004.001.008.0012	RT4A4R24	024 VAC 2 C/O RÖLE + SOKET + LED MODÜL + KLİPS + ETİKET		☎
001.004.001.008.0013	RT4A4T30	230 VAC 2 C/O RÖLE + SOKET + LED MODÜL + KLİPS + ETİKET		☎

SİP NO	TİPİ	AÇIKLAMA	Amb.	FİYAT
PCB RÖLE AKSESUARLARI				
001.003.001.002.0004	YRT 78625	08 PIN RAY TİPİ SOKET VİDALI KISA (1 C/O ve 2 C/O RÖLE İÇİN)	20	2,99 €
001.003.001.002.0006	YRT 78626	08 PIN RAY TİPİ SOKET VİDALI UZUN (1 C/O ve 2 C/O RÖLE İÇİN)	20	2,99 €
001.003.001.002.0007	RT 78725	08 PIN RAY TİPİ SOKET VİDALI KISA (1 C/O ve 2 C/O RÖLE İÇİN)	10	3,08 €
001.003.001.002.0008	RT 78726	08 PIN RAY TİPİ SOKET VİDALI UZUN (1 C/O ve 2 C/O RÖLE İÇİN)	10	3,08 €
001.003.001.002.0009	RT 7872P	08 PIN RAY TİPİ SOKET YAYLI (1 C/O ve 2 C/O RÖLE İÇİN)	20	3,80 €
001.003.002.001.0003	RP 78600	05 PIN PCB TİPİ SOKET (V23057 RÖLE İÇİN)	100	0,92 €
001.003.002.001.0001	YRP 78601	05 PIN PCB TİPİ SOKET (1 C/O 3.5 mm RÖLE İÇİN)	100	0,92 €
001.003.002.001.0002	YRP 78602	08 PIN PCB TİPİ SOKET (1 C/O ve 2 C/O RÖLE İÇİN)	100	0,92 €
001.002.001.002.0001	RT 16016	KLİPS (YRT 78625 - YRT 78626 İÇİN)	20	0,20 €
001.002.001.002.0002	RT 17017	KLİPS (RT 78725 - RT 78726 İÇİN)	10	0,20 €
001.002.001.002.0010	XT 17017	KLİPS (XT TİPİ RÖLELER İÇİN RT 78725-RT 78726 UYUMLU)	10	0,22 €
001.002.001.002.0003	RP 16104	M KLİPS (RP ve XT TİPİ RÖLELER İÇİN YRT SOKETLERE UYUMLU)	20	0,20 €
001.002.001.002.0004	RT 16041	M KLİPS (78600-601-602 İÇİN)	100	0,20 €
001.002.001.002.0005	RY 16040	ETİKET (YRT 78625 - YRT 78626 İÇİN)	20	0,16 €
001.002.001.002.0006	RT 17040	ETİKET (RT 78725-RT 78726 İÇİN)	10	0,16 €
001.002.001.002.0007	RT 170R8	VİDALI SOKET KÖPRÜSÜ 8'Lİ	1	2,50 €
001.002.001.002.0009	RT 170P1	YAYLI SOKET KÖPRÜSÜ TEKLİ	1	0,75 €

PTML LED VE KORUMA MODÜLLERİ (RT SERİSİ SOKETLER İÇİN)				
001.002.002.001.0004	PTM L0 024	006-024 VDC LM 18 LED + KORUMA DIODU (A1 + / A2-)	10	2,15 €
001.002.002.001.0005	PTM L0 524	006-024 VAC LM 07 LED MODÜLÜ	10	2,25 €
001.002.002.001.0024	PTM L0 110	048-110 VDC LM 20 LED + KORUMA DIODU (A1 + / A2-)	10	2,30 €
001.002.002.001.0006	PTM L0 730	110-230 VAC LM 06 LED MODÜLÜ	10	2,30 €
001.002.002.001.0007	PTM T0 0A0	006-220 VDC LM 09 KORUMA DIODU (A1 + / A2 -)	10	2,15 €
001.002.002.001.0021	PTM V0 524	024 VAC LM 04 VARİSTÖR MODÜLÜ	10	2,30 €
001.002.002.001.0022	PTM V0 730	230 VAC LM 05 VARİSTÖR MODÜLÜ	10	2,30 €
001.002.002.001.0026	PTM U0 524	006-060 VAC LM 02 RC KORUMA MODÜLÜ	10	2,30 €
001.002.002.001.0025	PTM U0 730	110-230 VAC LM 03 RC KORUMA MODÜLÜ	10	2,30 €

RTL M LED VE KORUMA MODÜLLERİ (YRT SERİSİ SOKETLER İÇİN)				
001.002.002.001.0008	RTL M0 024	006-024 VDC LED + KORUMA DIODU (A1+ / A2-)	20	2,15 €
001.002.002.001.0010	RTL M0 048	024-060 VDC LED + KORUMA DIODU (A1+ / A2-)	20	2,15 €
001.002.002.001.0011	RTL M0 524	006-024 VAC LED MODÜLÜ	20	2,25 €
001.002.002.001.0023	RTL M0 110	110-230 VDC LED + KORUMA DIODU (A1+/A2-)	20	2,30 €
001.002.002.001.0012	RTL M0 730	110-230 VAC LED MODÜLÜ	20	2,30 €
001.002.002.001.0017	RPM U0 548	024-048 VAC RC KORUMA MODÜLÜ	20	2,30 €
001.002.002.001.0018	RPM U0 730	110-230 VAC RC KORUMA MODÜLÜ	20	2,30 €
001.002.002.001.0019	RPM T0 0A0	006-230 VDC KORUMA DIODU 1N4007 (A1+/A2-)	20	2,15 €

1 form C (CO) contact

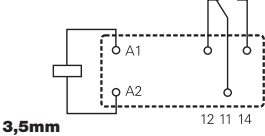

1 form C (CO) contact

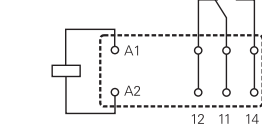

1 form C (CO) contact

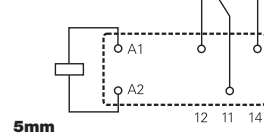

2 form C (CO) contacts

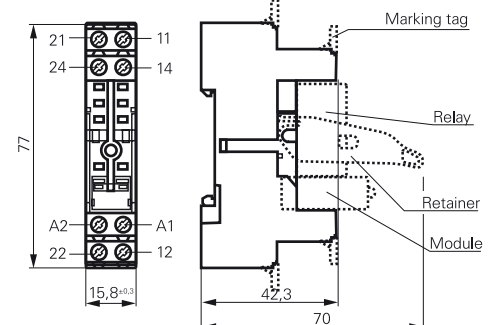
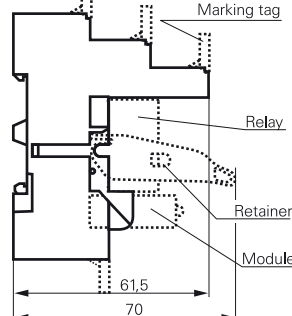
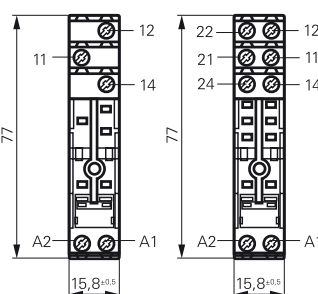
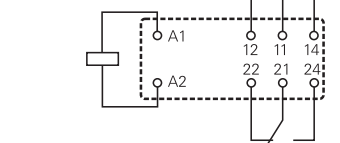

SİP NO	TİPİ	AÇIKLAMA	Amb.	FİYAT
PT SERİSİ ENDÜSTRİYEL RÖLELER (TEST BUTONLU)				
001.001.002.002.0003	PT 270024	024 VDC 2 C/O 12A END. RÖLE	10	4,40 €
001.001.002.002.0006	PT 270524	024 VAC 2 C/O 12A END. RÖLE		☎
001.001.002.002.0010	PT 270730	230 VAC 2 C/O 12A END. RÖLE	10	4,50 €
001.001.002.002.0016	PT 370012	012 VDC 3 C/O 10A END. RÖLE	10	4,40 €
001.001.002.002.0017	PT 370024	024 VDC 3 C/O 10A END. RÖLE	10	4,40 €
001.001.002.002.0019	PT 370048	048 VDC 3 C/O 10A END. RÖLE	10	6,43 €
001.001.002.002.0020	PT 370110	110 VDC 3 C/O 10A END. RÖLE	10	6,11 €
001.001.002.002.0022	PT 370125	125 VDC 3 C/O 10A END. RÖLE		☎
001.001.002.002.0021	PT 370220	220 VDC 3 C/O 10A END. RÖLE		☎
001.001.002.002.0023	PT 370524	024 VAC 3 C/O 10A END. RÖLE	10	4,40 €
001.001.002.002.0025	PT 370615	115 VAC 3 C/O 10A END. RÖLE	10	4,50 €
001.001.002.002.0026	PT 370730	230 VAC 3 C/O 10A END. RÖLE	10	5,20 €
001.001.002.002.0030	PT 570012	012 VDC 4 C/O 06A END. RÖLE	10	5,36 €
001.001.002.002.0032	PT 570024	024 VDC 4 C/O 06A END. RÖLE	10	4,40 €
001.001.002.002.0034	PT 570048	048 VDC 4 C/O 06A END. RÖLE	10	5,80 €
001.001.002.002.0036	PT 570060	060 VDC 4 C/O 06A END. RÖLE		☎
001.001.002.002.0038	PT 570110	110 VDC 4 C/O 06A END. RÖLE	10	6,00 €
001.001.002.002.0039	PT 570125	125 VDC 4 C/O 06A END. RÖLE		☎
001.001.002.002.0040	PT 570220	220 VDC 4 C/O 06A END. RÖLE	10	7,15 €
001.001.002.002.0041	PT 570512	012 VAC 4 C/O 06A END. RÖLE	10	6,00 €
001.001.002.002.0042	PT 570524	024 VAC 4 C/O 06A END. RÖLE	10	4,40 €
001.001.002.002.0044	PT 570548	048 VAC 4 C/O 06A END. RÖLE	10	7,04 €
001.001.002.002.0046	PT 570560	060 VAC 4 C/O 06A END. RÖLE		☎
001.001.002.002.0047	PT 570615	115 VAC 4 C/O 06A END. RÖLE	10	5,20 €
001.001.002.002.0048	PT 570730	230 VAC 4 C/O 06A END. RÖLE	10	5,20 €
001.001.002.002.0033	PT 570L24	024 VDC 4 C/O 06A END. RÖLE LEDLİ	10	4,98 €
001.001.002.002.0049	PT 570T30	230 VAC 4 C/O 06A END. RÖLE LEDLİ	10	5,90 €
PT SERİSİ PCB RÖLELER				
001.001.002.002.0013	PT 271012	012 VDC 2 C/O 12A END. RÖLE PCB TİP		☎
001.001.002.002.0028	PT 371024	024 VDC 3 C/O 10A END. RÖLE PCB TİP		☎
001.001.002.002.0050	PT 571012	012 VDC 4 C/O 06A END. RÖLE PCB TİP		☎
001.001.002.002.0051	PT 571024	024 VDC 4 C/O 06A END. RÖLE PCB TİP	10	5,95 €
001.001.002.002.0054	PT 571110	110 VDC 4 C/O 06A END. RÖLE PCB TİP	10	6,70 €
001.001.002.002.0053	PT 571220	220 VDC 4 C/O 06A END. RÖLE PCB TİP	10	7,25 €
PT SERİSİ RÖLE SETLERİ				
001.004.001.006.0019	PT3A5L24	024 VDC 3 C/O KONTAK RÖLE + SOKET + LED MODÜL + KLİPS + ETİKET		☎
001.004.001.006.0020	PT3A5R24	024 VAC 3 C/O KONTAK RÖLE + SOKET + LED MODÜL + KLİPS + ETİKET		☎
001.004.001.006.0021	PT3A5T30	230 VAC 3 C/O KONTAK RÖLE + SOKET + LED MODÜL + KLİPS + ETİKET		☎
001.004.001.006.0018	PT5A5L24	024 VDC 4 C/O KONTAK RÖLE + SOKET + LED MODÜL + KLİPS + ETİKET		☎
001.004.001.006.0022	PT5A5R24	024 VAC 4 C/O KONTAK RÖLE + SOKET + LED MODÜL + KLİPS + ETİKET		☎
001.004.001.006.0023	PT5A5T30	230 VAC 4 C/O KONTAK RÖLE + SOKET + LED MODÜL + KLİPS + ETİKET		☎
PTF SERİSİ GÜÇ RÖLELERİ (2 x 15 A)				
001.001.002.004.0002	PTF 20524	024 VAC 2 C/O 15A END GÜÇ RÖLESİ	10	6,60 €
001.003.001.006.0002	YPT 789F0	PTF RÖLE SOKETİ	10	4,50 €



4 pole

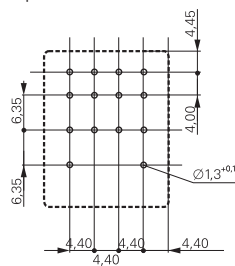

3 pole

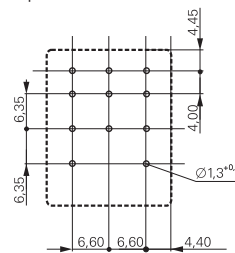

2 pole

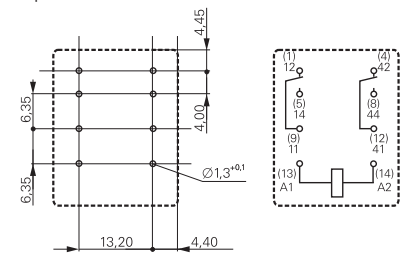

SİP NO	TİPİ	AÇIKLAMA	Amb.	FİYAT
PT SERİSİ RÖLE AKSESUARLARI				
001.003.001.003.0001	PT 78720	08 PIN RAY TİPİ SOKET VİDALI BAĞLANTI (2 C/O PT RÖLE İÇİN)	10	3,08 €
001.003.001.003.0007	YPT 78702	08 PIN RAY TİPİ SOKET VİDALI BAĞLANTI (2 C/O PT RÖLE İÇİN)	10	2,99 €
001.003.001.003.0003	PT 78730	11 PIN RAY TİPİ SOKET VİDALI BAĞLANTI (3 C/O PT RÖLE İÇİN)	10	3,08 €
001.003.001.003.0005	PT 78740	14 PIN RAY TİPİ SOKET VİDALI BAĞLANTI (2-4 C/O PT RÖLE İÇİN)	10	3,08 €
001.003.001.003.0008	YPT 78704	14 PIN RAY TİPİ SOKET VİDALI BAĞLANTI (2-4 C/O PT RÖLE İÇİN)	10	2,99 €
001.003.001.003.0013	PT 7874P	14 PIN RAY TİPİ SOKET YAY BAĞLANTILI (2-4 C/O PT RÖLE İÇİN)	10	4,60 €
001.003.001.003.0009	PT 78603	11 PIN PCB TİPİ SOKET (3 C/O RÖLE İÇİN)	25	1,75 €
001.003.001.003.0011	YPT 78604	14 PIN PCB TİPİ SOKET (4 C/O RÖLE İÇİN)	45	1,75 €
001.002.002.002.0002	PT 16017	KLİPS (YPT 78702-704 İÇİN)	10	0,45 €
001.002.002.002.0003	PT 17016	KLİPS (78720-730-740 İÇİN) TUTUCU TİP	10	0,45 €
001.002.002.002.0004	PT 17024	KLİPS (78720-730-740 İÇİN) TUTUCU-SÖKÜCÜ TİP	10	0,48 €
001.002.002.002.0005	PT 28800	KLİPS (78720-730-740 İÇİN) METAL	10	0,54 €
001.002.002.002.0006	PT 16040	ETİKET (YPT 78702-704 İÇİN)	10	0,18 €
001.002.002.002.0007	PT 17040	ETİKET (78720-730-740 İÇİN)	10	0,18 €
001.002.002.002.0013	CBPYF-5	VİDALI SOKET KÖPRÜSÜ 5'Lİ	10	2,50 €



PTML LED VE KORUMA MODÜLLERİ (RT SERİSİ SOKETLER İÇİN)				
001.002.002.001.0004	PTM L0 024	006-024 VDC LM 18 LED +KORUMA DİODU (A1+/A2-)	10	2,15 €
001.002.002.001.0005	PTM L0 524	006-024 VAC LM 07 LED MODÜLÜ	10	2,25 €
001.002.002.001.0024	PTM L0 110	048-110 VDC LM 20 LED +KORUMA DİODU (A1+/A2-)	10	2,30 €
001.002.002.001.0006	PTM L0 730	110-230 VAC LM 06 LED MODÜLÜ	10	2,30 €
001.002.002.001.0007	PTM T0 0A0	006-220 VDC LM 09 KORUMA DİADU (A1 + / A2 -)	10	2,15 €
001.002.002.001.0021	PTM V0 524	024 VAC LM 04 VARİSTÖR MODÜLÜ	10	2,30 €
001.002.002.001.0022	PTM V0 730	230 VAC LM 05 VARİSTÖR MODÜLÜ	10	2,30 €
001.002.002.001.0026	PTM U0 524	006-060 VAC LM 02 RC KORUMA MODÜLÜ	10	2,30 €
001.002.002.001.0025	PTM U0 730	110-230 VAC LM 03 RC KORUMA MODÜLÜ	10	2,30 €



RTL LED VE KORUMA MODÜLLERİ (YRT SERİSİ SOKETLER İÇİN)				
001.002.002.001.0008	RTL M0 024	006-024 VDC LED+KORUMA DİODU (A1+/A2-)	20	2,15 €
001.002.002.001.0010	RTL M0 048	024-060 VDC LED+KORUMA DİODU (A1+/A2-)	20	2,15 €
001.002.002.001.0011	RTL M0 524	006-024 VAC LED MODÜLÜ	20	2,25 €
001.002.002.001.0023	RTL M0 110	110-230 VDC LED+KORUMA DİODU (A1+/A2-)	20	2,30 €
001.002.002.001.0012	RTL M0 730	110-230 VAC LED MODÜLÜ	20	2,30 €
001.002.002.001.0017	RPM U0 548	024-048 VAC RC KORUMA MODÜLÜ	20	2,30 €
001.002.002.001.0018	RPM U0 730	110-230 VAC RC KORUMA MODÜLÜ	20	2,30 €
001.002.002.001.0019	RPM T0 0A0	006-230 VDC KORUMA DİODU 1N4007 (A1+/A2-)	20	2,15 €

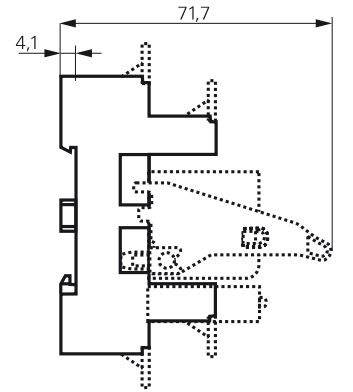
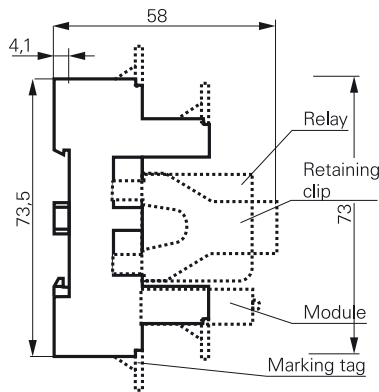
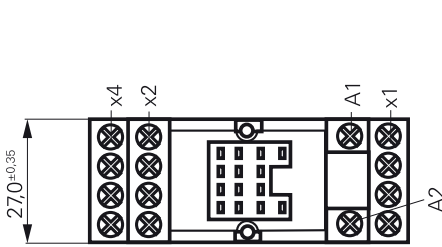

Dimensions

Solder- and plug-in terminals (standard version)

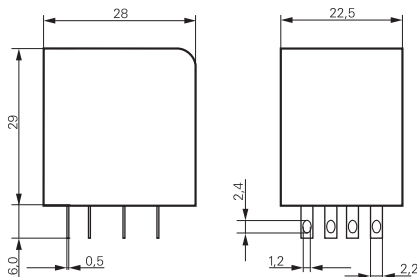

PT17016

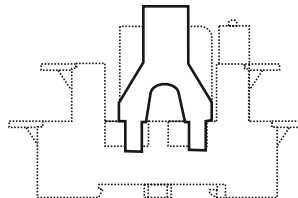

PT17024

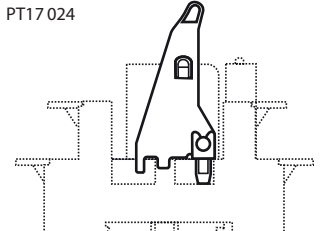

SİP NO	TİPİ	AÇIKLAMA	Amb.	FİYAT
MT SERİSİ ENDÜSTRİYEL RÖLELER (TEST BUTONLU - YUVARLAK PİNLİ)				
001.001.002.003.0001	MT 221024	024 VDC 2 C/O 10A END. RÖLE	25	6,95 €
001.001.002.003.0005	MT 226230	230 VAC 2 C/O 10A END. RÖLE		☎
001.001.002.003.0008	MT 321012	012 VDC 3 C/O 10A END. RÖLE	25	7,50 €
001.001.002.003.0009	MT 321024	024 VDC 3 C/O 10A END. RÖLE	25	7,50 €
001.001.002.003.0010	MT 321048	048 VDC 3 C/O 10A END. RÖLE	25	8,70 €
001.001.002.003.0011	MT 321060	060 VDC 3 C/O 10A END. RÖLE		☎
001.001.002.003.0013	MT 321110	110 VDC 3 C/O 10A END. RÖLE	25	8,50 €
001.001.002.003.0014	MT 321125	125 VDC 3 C/O 10A END. RÖLE		☎
001.001.002.003.0016	MT 321220	220 VDC 3 C/O 10A END. RÖLE		☎
001.001.002.003.0023	MT 326024	024 VAC 3 C/O 10A END. RÖLE	25	7,60 €
001.001.002.003.0024	MT 326048	048 VAC 3 C/O 10A END. RÖLE		☎
001.001.002.003.0025	MT 326060	060 VAC 3 C/O 10A END. RÖLE		☎
001.001.002.003.0026	MT 326115	115 VAC 3 C/O 10A END. RÖLE	25	8,40 €
001.001.002.003.0028	MT 326230	230 VAC 3 C/O 10A END. RÖLE	25	7,90 €
001.001.002.003.0018	MT 323024	024 VDC 3 C/O 10A END. RÖLE LEDLİ		☎
001.001.002.003.0020	MT 3230C4	024 VDC 3 C/O 10A END. RÖLE LED+KORUMA DİODU		☎
001.001.002.003.0029	MT 328024	024 VAC 3 C/O 10A END. RÖLE LEDLİ		☎
001.001.002.003.0027	MT 328115	115 VAC 3 C/O 10A END. RÖLE LEDLİ		☎
001.001.002.003.0030	MT 328230	230 VAC 3 C/O 10A END. RÖLE LEDLİ		☎

MT SERİSİ RÖLE AKSESUARLARI				
001.003.001.004.0003	YMT 78755	08 PIN RAY TİPİ SOKET (2 C/O MT RÖLE İÇİN)	10	2,99 €
001.003.001.004.0004	YMT 78750	11 PIN RAY TİPİ SOKET (3 C/O MT RÖLE İÇİN)	10	2,99 €
001.003.001.004.0002	MT 78750	11 PIN RAY TİPİ SOKET (3 C/O MT RÖLE İÇİN)	10	3,08 €
001.003.001.004.0007	MT 78740	11 PIN RAY TİPİ SOKET (MODÜL TAKILIR)	10	5,20 €
001.003.001.004.0010	MT 78613	11 PIN PCB TİPİ SOKET (3 C/O RÖLE İÇİN)		☎
001.002.002.003.0001	MT 28800	METAL SOKET KLİPSİ	10	0,85 €
001.002.002.003.0007	MTML0024	024 AC/DC LED MODÜLÜ		☎
001.002.002.003.0004	MTML0730	110-230 AC/DC LED MODÜLÜ		☎
001.002.002.003.0002	MTMT00A0	006-230 VDC KORUMA MODÜLÜ 1N4007		☎
001.002.002.003.0003	MTMF0W00	024-240 VAC MULTİ FONKSİYON ZAMAN MODÜLÜ		☎

RM SERİSİ GÜÇ RÖLELERİ				
001.001.002.005.0002	RM 232024	024 VDC 2 C/O 16A SOKET MONTAJLI	25	9,90 €
001.001.002.005.0026	RM 232524	024 VAC 2 C/O 16A SOKET MONTAJLI		☎
001.001.002.005.0003	RM 232730	230 VAC 2 C/O 16A SOKET MONTAJLI	25	10,55 €
001.001.002.005.0001	RM 205730	230 VAC 2 C/O 16A FLANŞLI	25	11,50 €
001.001.002.005.0008	RM 732024	024 VDC 3 C/O 16A SOKET MONTAJLI	25	10,50
001.001.002.005.0029	RM 732524	024 VAC 3 C/O 16A SOKET MONTAJLI		☎
001.001.002.005.0009	RM 732615	115 VAC 3 C/O 16A SOKET MONTAJLI		☎
001.001.002.005.0010	RM 732730	230 VAC 3 C/O 16A SOKET MONTAJLI	25	11,00
001.001.002.005.0007	RM 705730	230 VAC 3 C/O 16A FLANŞLI		☎

RM SERİSİ GÜÇ RÖLESİ AKSESUARI				
001.003.001.005.0002	RM 78705	RAY TİP SOKET RM232- RM732 SERİLERİ İÇİN	25	6,90 €

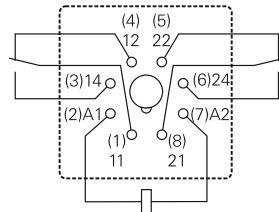
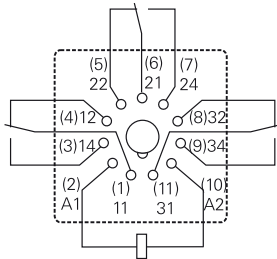

MT 78750

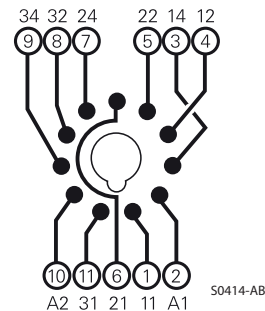

MT 78755

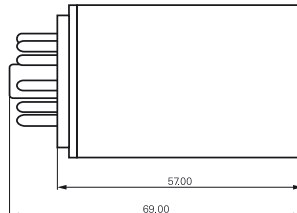
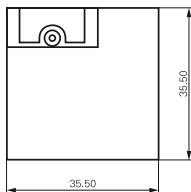
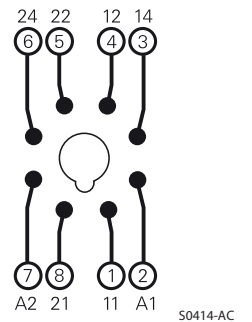

SİP NO **TİPİ** **AÇIKLAMA** **Amb.** **FİYAT**



KORUMA RÖLELERİ					
001.001.002.006.0009	SR4 D4 024	024 VDC 2NO/2NC 08A	KORUMA RÖLESİ	10	20,00 €
001.001.002.006.0010	SR4 M4 024	024 VDC 3NO/1NC 08A	KORUMA RÖLESİ	10	20,00 €
001.001.002.006.0021	SR6 D4 024	024 VDC 2NO/2NC 08A	KORUMA RÖLESİ	10	22,00 €
001.001.002.006.0005	V23050-A1024-A533	024 VDC 3NO/3NC 08A	KORUMA RÖLESİ	10	30,00 €
001.001.002.006.0006	V23050-A1024-A542	024 VDC 4NO/2NC 08A	KORUMA RÖLESİ	10	30,00 €



RE SERİSİ MİNYATÜR RÖLELER (200 mW)					
001.001.001.007.0001	RE 030005	005 VDC 1 N/O 06A	MİNİ PCB RÖLE	25	2,04 €
001.001.001.007.0003	RE 030012	012 VDC 1 N/O 06A	MİNİ PCB RÖLE	25	2,04 €
001.001.001.007.0005	RE 030024	024 VDC 1 N/O 06A	MİNİ PCB RÖLE		



PE SERİSİ MİNYATÜR RÖLELER (200 mW)					
001.001.001.007.0009	PE 014005	005 VDC 1 C/O 05A	MİNİ PCB RÖLE	25	2,15 €
001.001.001.007.0010	PE 014012	012 VDC 1 C/O 05A	MİNİ PCB RÖLE	25	2,15 €
001.001.001.007.0011	PE 014024	024 VDC 1 C/O 05A	MİNİ PCB RÖLE	25	2,15 €



RY SERİSİ MİNYATÜR RÖLELER					
001.001.001.008.0032	RY 611005	005 VDC 1 C/O 08A	PCB RÖLE 3.2 mm	20	2,15 €
001.001.001.008.0003	RY 211008	008 VDC 1 C/O 08A	PCB RÖLE 3.2 mm	20	2,15 €
001.001.001.008.0005	RY 211012	012 VDC 1 C/O 08A	PCB RÖLE 3.2 mm	20	2,15 €
001.001.001.008.0006	RY 211024	024 VDC 1 C/O 08A	PCB RÖLE 3.2 mm	20	2,15 €
001.001.001.008.0030	RY 531024	024 VDC 1 N/O 08A	PCB RÖLE 5.0 mm	20	2,15 €



TELEKOM RÖLELERİ					
001.001.001.009.0003	V23079-A2008-B301	003 VDC 2 C/O 05A	TELEKOM RÖLE 140 mW	50	1,73 €
001.001.001.009.0029	V23079-A2001-B301	005 VDC 2 C/O 05A	TELEKOM RÖLE 140 mW	50	1,73 €
001.001.001.009.0006	V23105-A5501-A201	005 VDC 2 C/O 03A	TELEKOM RÖLE 500 mW	25	1,73 €
001.001.001.009.0007	V23105-A5502-A201	006 VDC 2 C/O 03A	TELEKOM RÖLE 500 mW	25	1,73 €
001.001.001.009.0011	V23105-A5503-A201	012 VDC 2 C/O 03A	TELEKOM RÖLE 500 mW	25	1,73 €
001.001.001.009.0012	V23105-A5505-A201	024 VDC 2 C/O 03A	TELEKOM RÖLE 500 mW	25	1,73 €
001.001.001.009.0013	V23105-A5507-A201	048 VDC 2 C/O 03A	TELEKOM RÖLE 500 mW	25	1,73 €
001.001.001.009.0014	V23105-A5305-A201	024 VDC 2 C/O 03A	TELEKOM RÖLE 200 mW	25	1,73 €



OEG RÖLELERİ					
001.001.001.010.0040	OJ-SS-112LMH2,005	012 VDC 1 N/O 08A	MİNİ PCB RÖLE 200 mW	100	1,32 €
001.001.001.010.0068	PCJ-124D3M-WG,000M	024 VDC 1 N/O 05A	MİNİ PCB RÖLE 200 mW	75	1,32 €
001.001.001.010.0060	EJ05-1A4-D024-F	024 VDC 1 N/O 05A	MİNİ PCB RÖLE 200 mW	100	1,32 €
001.001.001.010.0058	PCH-105L2M,000	005 VDC 1 N/O 05A	MİNİ PCB RÖLE 200 mW	100	1,45 €
001.001.001.010.0057	PCH-112L2M,000	012 VDC 1 N/O 05A	MİNİ PCB RÖLE 200 mW	100	1,45 €
001.001.001.010.0059	PCH-124L2M,000	024 VDC 1 N/O 05A	MİNİ PCB RÖLE 200 mW	100	1,45 €
001.001.001.010.0046	PCH-112D2H,000	012 VDC 1 C/O 05A	MİNİ PCB RÖLE 400 mW	100	1,45 €



KÜP RÖLELERİ					
001.001.001.010.0062	T73-12VDC	012 VDC 1 C/O 10A	KÜP RÖLE	25	0,45 €
001.001.001.010.0063	T73-24VDC	024 VDC 1 C/O 10A	KÜP RÖLE	25	0,45 €
001.001.001.010.0048	CHW-S-105DC2	005 VDC 1 C/O 10A	KÜP RÖLE	50	0,65 €
001.001.001.010.0049	CHW-S-112DC2	012 VDC 1 C/O 10A	KÜP RÖLE	50	0,65 €
001.001.001.010.0050	CHW-S-124DC2	024 VDC 1 C/O 10A	KÜP RÖLE	50	0,65 €
001.001.001.010.0005	ORWH-SH-112D	012 VDC 1 C/O 10A	KÜP RÖLE	50	0,85 €
001.001.001.010.0006	ORWH-SH-124D	024 VDC 1 C/O 10A	KÜP RÖLE	50	0,85 €



GÜÇ RÖLELERİ					
001.001.002.009.0022	T9AS1D22-12	012 VDC 1 N/O 30A	PCB + FESTON GİRİŞLİ POWER RÖLE	50	2,40 €
001.001.002.009.0021	T9AS1D12-12	012 VDC 1 N/O 30A	PCB TİP POWER RÖLE	50	2,40 €
001.001.002.009.0020	T9AS1D12-24	024 VDC 1 N/O 30A	PCB TİP POWER RÖLE	50	2,75 €
001.001.002.009.0019	T92S7D12-24	024 VDC 2 N/O 30A	PCB TİP POWER RÖLE	50	2,75 €

SİP NO	TİPİ	AÇIKLAMA	Amb.	FİYAT
SUPER SEAL TERMİNAL YUVALARI				
003.001.002.001.0013	282079-2	1 PIN DIŞI TERMİNAL YUVASI	100	0,50 €
003.001.002.001.0001	282080-1	2 PIN DIŞI TERMİNAL YUVASI	100	0,52 €
003.001.002.001.0002	282087-1	3 PIN DIŞI TERMİNAL YUVASI	100	0,62 €
003.001.002.001.0003	282088-1	4 PIN DIŞI TERMİNAL YUVASI	100	0,76 €
003.001.002.001.0012	282089-1	5 PIN DIŞI TERMİNAL YUVASI	100	0,82 €
003.001.002.001.0004	282090-1	6 PIN DIŞI TERMİNAL YUVASI	100	1,03 €
003.001.002.001.0014	282103-1	1 PIN ERKEK TERMİNAL YUVASI	100	0,50 €
003.001.002.001.0005	282104-1	2 PIN ERKEK TERMİNAL YUVASI	100	0,52 €
003.001.002.001.0006	282105-1	3 PIN ERKEK TERMİNAL YUVASI	100	0,62 €
003.001.002.001.0007	282106-1	4 PIN ERKEK TERMİNAL YUVASI	100	0,76 €
003.001.002.001.0009	282107-1	5 PIN ERKEK TERMİNAL YUVASI	100	0,82 €
003.001.002.001.0010	282108-1	6 PIN ERKEK TERMİNAL YUVASI	100	1,03 €

SİP NO	TİPİ	AÇIKLAMA	Amb.	FİYAT
SUPER SEAL TERMİNALLER				
003.001.002.002.0006	282403-1	0.35-0.50 mm2 DIŞI TERMİNAL	1000	0,08 €
003.001.002.002.0001	282110-1	0.75-1.50 mm2 DIŞI TERMİNAL	1000	0,10 €
003.001.002.002.0002	282466-1	1.50-2.50 mm2 DIŞI TERMİNAL	1000	0,12 €
003.001.002.002.0003	282404-1	0.35-0.50 mm2 ERKEK TERMİNAL	1000	0,06 €
003.001.002.002.0004	282109-1	0.75-1.50 mm2 ERKEK TERMİNAL	1000	0,08 €
003.001.002.002.0005	282465-1	1.50-2.50 mm2 ERKEK TERMİNAL	1000	0,10 €

SİP NO	TİPİ	AÇIKLAMA	Amb.	FİYAT
SUPER SEAL KORUYUCU KAPAKLAR				
003.001.019.001.0014	880810-1	2 Lİ KORUYUCU KAPAK	1000	1,44 €
003.001.002.003.0006	880811-2	3 LÜ KORUYUCU KAPAK	1000	1,54 €
003.001.002.003.0005	493581-1	4 LÜ KORUYUCU KAPAK	1000	1,60 €

SİP NO	TİPİ	AÇIKLAMA	Amb.	FİYAT
SUPER SEAL SIZDIRMAZLIK CONTLARI				
003.001.002.003.0004	281934-4	0.35-0.50 mm2 CONTA (YEŞİL)	1000	0,05 €
003.001.002.003.0001	281934-2	0.75-1.50 mm2 CONTA (SARI)	1000	0,05 €
003.001.002.003.0002	281934-3	1.50-2.50 mm2 CONTA (KIRMIZI)	1000	0,05 €
003.001.002.003.0003	282081-1	KÖR TAPA	1000	0,06 €

SİP NO	TİPİ	AÇIKLAMA	Amb.	FİYAT
SUPER SEAL EL ALETLERİ				
003.001.002.004.0001	9-1579007-1	PİN ÇIKARMA ALETİ		
003.001.019.004.0069	539635-1 +539773-2	TERMİNAL SIKMA PENSESİ		

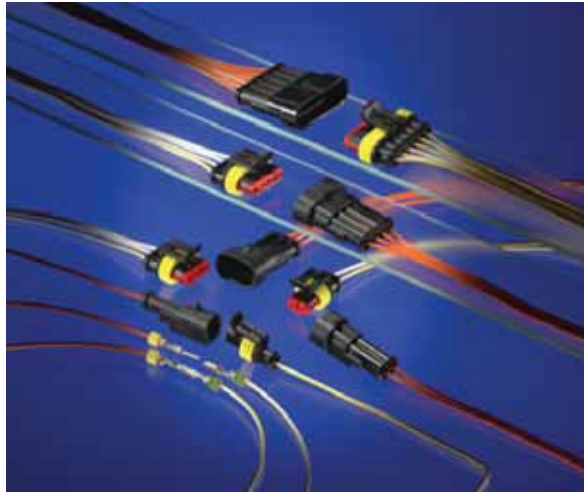

SİP NO	TİPİ	AÇIKLAMA	Amb.	FİYAT
KOPRÜ DİODLAR				
004.002.001.000.0001	KBPC35A	35 A 1000 V KÖPRÜ DİOD	50	0,90 \$
POZİSYON İNDİKATÖRLERİ				
004.002.003.001.0001	SI10-B	090-230 AC/DC POZİSYON İNDİKATÖRÜ	1	22,00 \$
004.002.003.001.0002	SI10-B	024 AC/DC POZİSYON İNDİKATÖRÜ	1	22,00 \$
004.002.003.001.0003	SI10-B	048 AC/DC POZİSYON İNDİKATÖRÜ	1	22,00 \$
004.002.003.001.0004	SI10-T	090-230 AC/DC POZİSYON İNDİKATÖRÜ	1	22,00 \$
004.002.003.001.0005	SI10-T	024 AC/DC POZİSYON İNDİKATÖRÜ	1	22,00 \$
004.002.003.001.0006	SI10-T	048 AC/DC POZİSYON İNDİKATÖRÜ	1	22,00 \$
PANO AKSESUARLARI				
002.004.006	PC-050G	PROJE CEBİ A5 GRİ	20	4,30 ₺
002.004.005	PC-050S	PROJE CEBİ A5 ŞEFFAF	20	4,30 ₺
002.004.001	PC-100G	PROJE CEBİ A4 GRİ	20	5,40 ₺
002.004.002	PC-100S	PROJE CEBİ A4 ŞEFFAF	20	5,40 ₺
002.004.004	EK-35	ESNEK KABLO KANALI 25cm ÇAP : 35 mm (EKLENEBİLİR)	200	2,75 ₺
002.004.008.001.0001	LV-10	110-230 VAC PANO AYDINLATMA ARMATÜRÜ	1	19,80 \$
TERMOSTATLAR VE HİDROSTATLAR				
002.002.001.001.0001	TY-90-B3	0 °C & 30 °C ODA TERMOSTATI (CAMPINI)	1	11,50 €
002.002.001.004.0001	RT 802	230 VAC 10A ELEKTRONİK TERMOSTAT (-20 °C & + 120 °C)	1	16,50 €
002.002.001.004.0004	NTC PROB	NTC PROB 1.5 METRE	1	3,20 €
002.002.001.002.0002	JWT-6011R	230 AC 1 N/C 10A PANO TERMOSTATI 0 & 60 °C (KIRMIZI) ISITICI	10	5,20 \$
002.002.001.002.0004	JWT-6011F	230 AC 1 N/O 10A PANO TERMOSTATI 0 & 60 °C (MAVİ) FAN	10	5,20 \$
002.002.001.002.0011	JWT-6012	230 AC 1 N/O + 1N/C İKİLİ TERMOSTAT 0 & 60 °C (KIRMIZI + MAVİ)	1	16,00 \$
002.002.001.003.0003	JWH-6015	230 AC 1 C/O 10A MEKANİK HİDROSTAT (% 10 & % 80)	1	35,00 \$
002.002.001.002.0001	TH-H	230 AC 1 N/C 10A PANO TERMOSTATI 0 & 60 °C (KIRMIZI) ISITICI	1	9,00 €
002.002.001.002.0012	TH-H-20	230 AC 1 N/C 10A PANO TERMOSTATI 0 & 60 °C (KIRMIZI) (-20 & + 40 °C)	1	11,00 €
002.002.001.002.0003	TH-K	230 AC 1 N/O 10A PANO TERMOSTATI 0 & 60 °C (MAVİ) FAN	1	9,00 €
002.002.001.003.0001	HY / WE	230 AC 1 C/O 10A MEKANİK HİDROSTAT (% 10 & % 80)	1	40,00 €
002.002.001.003.0002	HY / TH COMBİ	230 AC 1 C/O 10A MEKANİK HİDROSTAT + 1 NC TERMOSTAT	1	75,00 €
RO/SE PANO ISITICILARI				
002.003.002.001.0002	SD/S1-025	230 AC 025W PANO ISITICI 075 x 060 x 045	1	42,00 €
002.003.002.001.0003	SD/S3-050	230 AC 050W PANO ISITICI 075 x 116 x 045	1	46,00 €
002.003.002.001.0004	SD/S4-100	230 AC 100W PANO ISITICI 075 x 166 x 045	1	49,00 €
002.003.002.001.0005	SD/S5-150	230 AC 150W PANO ISITICI 075 x 216 x 045	1	68,00 €
002.003.002.001.0006	SD/S6-250	230 AC 250W PANO ISITICI 075 x 316 x 045	1	78,00 €
002.003.002.002.0001	HG-VARIO	230 AC 250W PANO ISITICI 080 x 110 x 188 FANLI	1	134,00 €
HİLKAR PANO ISITICILARI				
002.003.001.002.002	HR-PTC-050	230 AC 050 W PANO ISITICI PTC TİPİ 70 X 070 X 50	1	26,00 \$
002.003.001.002.003	HR-PTC-100	230 AC 100 W PANO ISITICI PTC TİPİ 70 X 140 X 50	1	34,00 \$
002.003.001.001.0002	HR 050	230 AC 050 W PANO ISITICI 40 X 135 X 42.5	1	48,00 ₺
002.003.001.001.0003	HR 100	230 AC 100 W PANO ISITICI 40 X 135 X 42.5	1	48,00 ₺
002.003.001.001.0007	HRY 050	230 AC 050 W PANO ISITICI YASSI TİP (2M KABLOLU)	1	24,00 €
002.003.001.001.0008	HRY 100	230 AC 100 W PANO ISITICI YASSI TİP (2M KABLOLU)	1	24,00 €
002.003.001.001.0016	TKR-2	100 V 47 OHM SARGI DİRENCİ	1	34,00 \$

SİP NO	TİPİ	AÇIKLAMA	Amb.	FİYAT
DC FANLAR				
002.001.002.001.0006	080-080-025 012 DC	012VDC 055 M3/h FAN	100	2,50 \$
002.001.002.001.0008	080-080-025 024 DC	024VDC 065 M3/h FAN	100	2,50 \$
002.001.002.001.0009	120-120-025 012 DC	012VDC 122 M3/h FAN	100	6,00 \$
002.001.002.001.0010	120-120-025 024 DC	024VDC 125 M3/h FAN	100	6,00 \$
002.001.002.001.0011	120-120-038 012 DC	012VDC 140 M3/h FAN	40	6,00 \$
002.001.002.001.0003	120-120-038 024 DC	024VDC 140 M3/h FAN	40	6,00 \$
002.001.002.001.0004	120-120-038 048 DC	048VDC 150 M3/h FAN	40	9,80 \$
002.001.002.001.0012	172-150-050 012 DC	012VDC 262 M3/h FAN	12	18,00 \$
002.001.002.001.0005	172-150-050 024 DC	024VDC 270 M3/h FAN	12	18,00 \$
AC FANLAR				
002.001.001.004.0001	080-080-025 230 AC	230 VAC 026 M3/h FAN	50	5,00 \$
002.001.001.004.0002	080-080-038 230 AC	230 VAC 039 M3/h FAN	50	5,00 \$
002.001.001.004.0004	108-108-026 230 AC	230 VAC 051 M3/h FAN	50	5,00 \$
002.001.001.001.0001	120-120-025 230 AC	230 VAC 065 M3/h FAN	40	5,00 \$
002.001.001.001.0002	120-120-038 110 AC	110 VAC 153 M3/h FAN		8
002.001.001.001.0003	120-120-038 230 AC	230 VAC 153 M3/h FAN KABLOLU	40	4,60 \$
002.001.001.001.0005	120-120-038 230 AC	230 VAC 153 M3/h FAN RULMANLI	40	7,00 \$
002.001.001.002.0005	172-150-050 110 AC	230 VAC 270 M3/h FAN	12	18,00 \$
002.001.001.002.0001	172-150-050 230 AC	230 VAC 270 M3/h FAN	12	16,00 \$
002.001.001.002.0003	172-163-050 230 AC	230 VAC 270 M3/h FAN	12	16,00 \$
002.001.001.003.0001	200-200-060 230 AC	230 VAC 300 M3/h FAN YUVARLAK	10	24,00 \$
002.001.001.003.0002	200-200-060 230 AC	230 VAC 300 M3/h FAN KARE	10	26,00 \$
002.001.001.003.0004	225-225-080 230 AC	230 VAC 1020 M3/h FAN	5	80,00 \$
002.001.001.003.0006	280-280-080 230 AC	230 VAC 1850 M3/h FAN	5	110,00 \$



600-030



600-070



600-090



600-096



600-130



600-100

SİP NO	TİPİ	AÇIKLAMA	Amb.	FİYAT
FAN SETLERİ				
002.001.005.001.0002	FS105-A2	230 VAC 030 M3/h FAN SETİ (105 x 105 x 055) GRİ R7035	1	9,20 \$
002.001.005.001.0003	FS150-A1	230 VAC 100 M3/h FAN SETİ (150 x 150 x 060) BEJ R7032	1	9,50 \$
002.001.005.001.0004	FS150-A2	230 VAC 100 M3/h FAN SETİ (150 x 150 x 060) GRİ R7035	1	9,50 \$
002.001.005.001.0007	FS250-A1	230 VAC 190 M3/h FAN SETİ (250 x 250 x 075) BEJ R7032	1	30,00 \$
002.001.005.001.0008	FS250-A2	230 VAC 190 M3/h FAN SETİ (250 x 250 x 075) GRİ R7035	1	30,00 \$
002.001.005.001.0010	FS250-B2	230 VAC 200 M3/h FAN SETİ (250 x 250 x 110) GRİ R7035 DAVLUMBAZLI	1	35,00 \$
002.001.005.001.0015	FS250-E1	230 VAC 780 M3/h FAN SETİ (250 x 250 x 110) BEJ R7032	1	100,00 \$
002.001.005.001.0016	FS250-E2	230 VAC 780 M3/h FAN SETİ (250 x 250 x 110) GRİ R7035	1	100,00 \$

FAN FİLTRELERİ				
002.001.003.001.0002	F105-A20	105 x 105 FAN FİLTRESİ GRİ R7035	10	3,85 ₺
002.001.003.001.0003	F150-A10	150 x 150 FAN FİLTRESİ BEJ R7032	10	4,75 ₺
002.001.003.001.0004	F150-A20	150 x 150 FAN FİLTRESİ GRİ R7035	10	4,75 ₺
002.001.003.001.0005	F150-A30	150 x 150 FAN FİLTRESİ SYH R9005	10	4,75 ₺
002.001.003.001.0007	F250-A10	250 X 250 FAN FİLTRESİ BEJ R7032 ÇAP:150	10	16,50 ₺
002.001.003.001.0008	F250-A20	250 X 250 FAN FİLTRESİ GRİ R7035 ÇAP:150	10	16,50 ₺
002.001.003.001.0009	F250-A30	250 X 250 FAN FİLTRESİ SYH R9005 ÇAP:150	10	16,50 ₺
002.001.003.001.0010	F250-A11	250 X 250 FAN FİLTRESİ BEJ R7032 ÇAP:210	10	16,50 ₺
002.001.003.001.0011	F250-A21	250 X 250 FAN FİLTRESİ GRİ R7035 ÇAP:210	10	16,50 ₺
002.001.003.001.0012	F250-A31	250 X 250 FAN FİLTRESİ SYH R9005 ÇAP:210	10	16,50 ₺
002.001.003.001.0014	F250-B20	250 X 250 FAN FİLTRESİ GRİ R7035 DERİN TİP	10	19,80 ₺

FAN TELLERİ				
002.001.004.001.0001	MK 080	080 X 080 METAL FAN KORUMA TELİ	10	0,50 \$
002.001.004.001.0002	MK 120	120 X 120 METAL FAN KORUMA TELİ	10	0,60 \$
002.001.004.001.0003	MK 172	172 X 172 METAL FAN KORUMA TELİ	10	1,00 \$
002.001.004.001.0004	MK 200	225 X 225 METAL FAN KORUMA TELİ	10	2,60 \$
002.001.004.001.0006	MK 280	280 X 280 METAL FAN KORUMA TELİ	0	5,80 \$

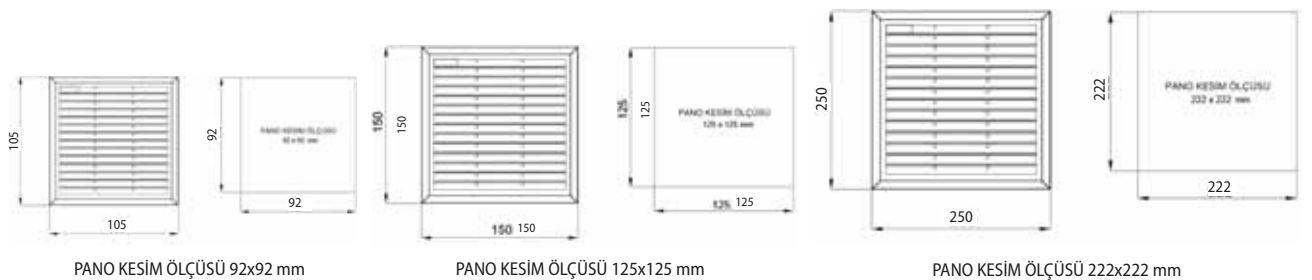

TE CONNECTIVITY PRODUCT PORTFOLIO

Input/Output (I/O)

1



Audio/Video & Data



CHAMP Product



Circular Industrial



D-Subminiature



High Speed



Mixed Power & Signal



Modular Jacks & Plugs



Rectangular Industrial



Sealed Automotive



Sealed Industrial



Shielded Data



Termination & Connection Devices

Power (>10Amps/Contact)

2



Battery



Board-to-Board



Bus Bar



Cable Splices & Taps



Convenience Outlets



Drawer



High Voltage



Wire Applied



Wire-to-Board



Wire-to-Wire

RF & Coax

3



Antenna Products



Miniature



Standard

Board-to-Board

4



Backplane/Midplane



Board-to-Board



Card Edge



Mezzanine

Fiber Optics

5



Advanced



Standard

EMI/RFI Filters



DC Filters



Power Entry Modules



Power Line



RF & Signal

Application Model

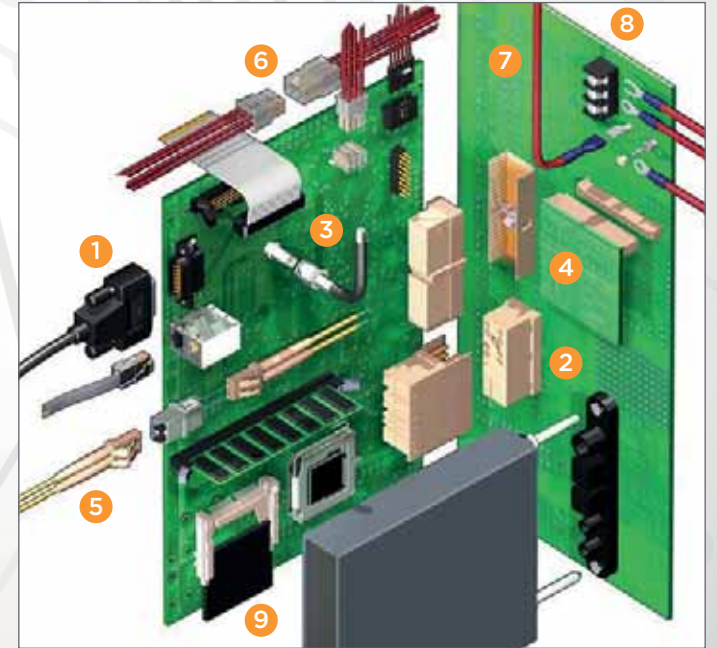

See corresponding product category

GENEL ŞARTLAR

- Fiyatlarımızda önceden haber verilmeden değişiklik yapma hakkımız saklıdır.
- Fiyatlarımıza KDV dahil değildir.
- Döviz bazlı fiyatlarımızda fatura tarihindeki TCMB döviz satış fiyatları referans alınır.
- Sevkiyatlarımız standart ambalajlara göre yapılır.
- Nakliye ücreti alıcıya aittir.
- Firmamızın onayı alınmadan iade kabul edilmez.
- İadesi kabul edilen ürünlerin nakliyesi alıcıya aittir.
- Listemizde yer almayan ürünler için lütfen satış bölümümüz ile temas kurunuz.

“Bizim seçimlerimiz,
Sizin çözümlerinizdir.”

www.te.com

RÖLE TEKNİK ELEKTRİK SAN. VE DIŐ TİC. LTD. ŐTİ.

Őerif Ali Mah. Mevdudi Sk. No:16
34775 Dudullu / Ümraniye - İST.

Tel. : +90 216 540 78 15 pbx
Fax : +90 216 540 78 40

www.roleteknik.com.tr
info@roleteknik.com.tr